



Professional in

- CLS (Liquid Handling Product's)

**Composite Lab Line Pvt Ltd**

# Pipettes

## TopPette Mechanical Pipettes

### Non Autoclavable

- Lightweight, ergonomic, low force design
- Digital display clearly reads volume setting
- The pipettes cover volume range of 0.1µl to 10ml
- Easy to calibrate and maintain with tool supplied
- Design helps avoid repetitive strain injuries
- Calibrated in accordance with ISO8655. Each pipette supplied with individual test certificate



### Single-Channel Adjustable Volume Pipette

TopPette Mechanical Pipettes

Cat No	Volume Range	Price
CLS-17571	0.1-2.5µl	5562.00
CLS-17572	0.5-10µl	5562.00
CLS-17573	5-50µl	5562.00
CLS-17574	2-20µl	5562.00
CLS-17575	10-100µl	5562.00
CLS-17576	20-200µl	5562.00
CLS-17577	50-200µl	5562.00
CLS-17578	100-1000µl	5562.00
CLS-17579	200-1000µl	5562.00
CLS-17580	1000-5000µl	5562.00
CLS-17581	2-10ml	5562.00

## MicroPette Mechanical Pipettes

### Semi Autoclavable

- Lightweight, ergonomic, low force design
- Digital display clearly reads volume setting
- The pipettes cover volume range of 0.1µl to 10ml
- Easy to calibrate and maintain with tool supplied
- Design helps avoid repetitive strain injuries
- Calibrated in accordance with ISO8655. Each pipette supplied with individual test certificate
- The low part is available for autoclaving
- Manufactured from innovative materials



### Single-Channel Adjustable Volume Pipette

MicroPette Mechanical Pipettes

Cat No	Volume Range	Price
CLS-17596	0.1-2.5µl	6197.00
CLS-17597	0.5-10µl	6197.00
CLS-17598	2-20µl	6197.00
CLS-17599	5-50µl	6197.00
CLS-17600	10-100µl	6197.00
CLS-17601	20-200µl	6197.00
CLS-17602	50-200µl	6197.00
CLS-17603	100-1000µl	6197.00
CLS-17604	200-1000µl	6197.00
CLS-17605	1000-5000µl	6197.00
CLS-17606	2-10ml	6197.00

## MicroPette Plus Autoclavable Pipette

### Fully Autoclavable

- Lightweight, ergonomic, low force design
- Digital display clearly reads volume setting
- The pipettes cover volume range of 0.1µl to 10ml
- Easy to calibrate and maintain with tool supplied
- Design helps avoid repetitive strain injuries
- Manufactured from innovative material
- Calibrated in accordance with ISO8655. Each pipette supplied with individual test certificate



### Single-Channel Adjustable Volume Pipette

MicroPette Plus Autoclavable Pipette

Cat No	Volume Range	Price
CLS-17582	0.1-2.5µl	6833.00
CLS-17583	0.5-10µl	6833.00
CLS-17584	2-20µl	6833.00
CLS-17585	5-50µl	6833.00
CLS-17586	10-100µl	6833.00
CLS-17587	20-200µl	6833.00
CLS-17588	50-200µl	6833.00
CLS-17589	100-1000µl	6833.00
CLS-17590	200-1000µl	6833.00
CLS-17591	1000-5000µl	6833.00
CLS-17592	2-10ml	6833.00

## 8-Channel TopPette

### Non Autoclavable

- 8 channel pipettes are available for standard 96-well plate
- Dispensing head rotates for optimum pipetting convenience
- Individual piston and tip cone assemblies allow easy repair and maintenance
- Compound material tip cone design allows visual seal verification
- Can be used with universal style pipette tips



### Adjustable Volume Pipette

TopPette Mechanical Pipettes

Cat No	Volume Range	Price
CLS-17593	0.5-10µl	25424.00
CLS-17594	5-50µl	25424.00
CLS-17595	50-300µl	25424.00

## 8-Channel MicroPette

### Semi Autoclavable

- 8 channel pipettes are available for standard 96-well plate
- Dispensing head rotates for optimum pipetting convenience
- Individual piston and tip cone assemblies allow easy repair and maintenance
- Compound material tip cone design allows visual seal verification
- Can be used with universal style pipette tips



### Adjustable Volume Pipette

MicroPette Mechanical Pipettes

Cat No	Volume Range	Price
CLS-17607	0.5-10µl	27013.00
CLS-17608	5-50µl	27013.00
CLS-17609	50-300µl	27013.00

### 8-Channel MicroPette Plus

**Fully Autoclavable**

- 8 channel pipettes are available for standard 96-well plate
- Dispensing head rotates for optimum pipetting convenience
- Individual piston and tip cone assemblies allow easy repair and maintenance
- Compound material tip cone design allows visual seal verification
- Can be used with universal style pipette tips



**Adjustable Volume Pipette**

MicroPette Plus Autoclavable Pipette

Cat No	Volume Range	Price
CLS-17610	0.5-10µl	28602.00
CLS-17611	5-50µl	28602.00
CLS-17612	50-300µl	28602.00

### 12-Channel TopPette

**Non Autoclavable**

- 12 channel pipettes are available for standard 96-well plate
- Dispensing head rotates for optimum pipetting convenience
- Individual piston and tip cone assemblies allow easy repair and maintenance
- Compound material tip cone design allows visual seal verification
- Can be used with universal style pipette tips



**Adjustable Volume Pipette**

TopPette Mechanical Pipettes

Cat No	Volume Range	Price
CLS-17617	0.5-10µl	27013.00
CLS-17618	5-50µl	27013.00
CLS-17619	50-300µl	27013.00

### 12-Channel MicroPette

**Semi Autoclavable**

- 12 channel pipettes are available for standard 96-well plate
- Dispensing head rotates for optimum pipetting convenience
- Individual piston and tip cone assemblies allow easy repair and maintenance
- Compound material tip cone design allows visual seal verification
- Can be used with universal style pipette tips



**Adjustable Volume Pipette**

MicroPette Mechanical Pipettes

Cat No	Volume Range	Price (₹)
CLS-17621	0.5-10µl	28602.00
CLS-17622	5-50µl	28602.00
CLS-17623	50-300µl	28602.00

### 12-Channel MicroPette Plus

**Fully Autoclavable**

- 12 channel pipettes are available for standard 96-well plate
- Dispensing head rotates for optimum pipetting convenience
- Individual piston and tip cone assemblies allow easy repair and maintenance
- Compound material tip cone design allows visual seal verification
- Can be used with universal style pipette tips



**Adjustable Volume Pipette**

MicroPette Plus Autoclavable Pipette

Cat No	Volume Range	Price
CLS-17613	0.5-10µl	30191.00
CLS-17614	5-50µl	30191.00
CLS-17615	50-300µl	30191.00

### Round Pipette Stand

The round stands have been designed to it perfectly of Pipette range, TopPette, MicroPette and MicroPette Plus Autoclavable Pipettes. The stands are convenient to hold up 6 pipettes both of single and multi-channel.

Cat No	Product	Price (₹)
CLS-17616	Round stand holds up to 6 pipettes, it of TopPette, MicroPette and MicroPette Plus	8800.00



### Linear Pipette Stand

The linear have been designed to it perfectly of Pipette range, TopPette, MicroPette and MicroPette Plus Autoclavable Pipettes. The stands are convenient to hold up 6 pipettes both of single and multi-channel.

Cat No	Product	Price (₹)
CLS-17620	Linear stand holds up to 6 pipettes, it of TopPette, MicroPette and MicroPette Plus	8200.00



### Single Channel Adjustable Electronic Pipette

**Description:-**

- A motor drive digital control pipette with multifunction Pipetting, Mixing, Stepper and Dilution
- 2 buttons handle all operation and setting
- A wide range of pipetting modules for selection
- Adjustable speeds for aspiration and dispensing
- Li-ion battery and two charging mode enable longer operation time
- Self calibration – By link it to a PC and a balance with USB connector.



Cat No	Volume Range	Increment	Price (₹)
CLS-17624	0.5-10uL	0.01uL	45000.00
CLS-17625	5-50uL	0.1uL	45000.00
CLS-17626	30-300uL	1uL	45000.00
CLS-17627	100-1000uL	5uL	45000.00

### Levo Plus Motorized Pipette Filter

- Full volume range of 0.1-100ml
- Easy to one-handed operation
- Lightweight, ergonomic designs allow longer, fatigue-free pipetting
- Efficient lithium-ion battery offers long runtime on each charge
- Low battery alert
- Powerful motor fills a 25ml pipette in <5 seconds
- Supplied with integral but replaceable 0.45um filter
- Can be used while charging
- Large LCD display provides visual confirmation of remaining battery charge and speed settings
- Eight speeds are available for aspirate and dispense liquid



Large LCD display provides visual confirmation of remaining battery charge and coarse speed settings

Select the desired speed by turning the speed adjustment wheel

Silicone adapter suitable for 0.1-100ml pipette, can be fully autoclaved at 121°C

Cat No	Product	Price
CLS-17628	Levo Plus with AC adapter spare 0.45µm filter and wall stand, Euro plug	19,500.00

### Purple Nitrile Powder-Free Gloves

#### Description

- Nitrile, synthetic rubber construction eliminates the possibility of latex-oriented allergic reactions
- Long, 9.5" ambidextrous design
- Get a good grip and an excellent fit
- Textured ingertips allow you to work with ease and confidence
- Easy-to-don beaded cuffs provide greater strength and durability
- Non-sterile for medical use



Cat No	Product	Pack Size	Price
CLS-PS	Purple nitrile Powder free Gloves, Small	100/pk 10pk/Case	850.00 7910.00
CLS-PM	Purple nitrile Powder free Gloves, Medium	100/pk 10pk/Case	850.00 7910.00
CLS-PL	Purple nitrile Powder free Gloves, Large	100/pk 10pk/Case	850.00 7910.00

### Nitrile Gloves Powder Free

An economical option with the full benefits of nitrile, this version comes in a thinner format which fits and feels like latex. Nitrile is resistant to a wide range of chemicals, and offers excellent tear strength and puncture resistance. Textured ingertips provide good grip in wet or dry applications. Latex free, ergonomic design for reduced hand fatigue.



Cat No	Product	Pack Size	Price
CLS-NS	Nitrile Powder free Gloves, Small	100/pk 10pk/Case	725.00 6887.00
CLS-NM	Nitrile Powder free Gloves, Medium	100/pk 10pk/Case	725.00 6887.00
CLS-NL	Nitrile Powder free Gloves, Large	100/pk 10pk/Case	725.00 6887.00

### Latex Examination Powder Free Gloves

The feel and fit of all-natural rubber latex is a powder free alternative. Featuring low protein content, leaving your hands soft and comfortable. Ergonomic design for reduced hand fatigue and stiffness. Easily donned and removed. Fully textured surface allowing for superior grip control, tactile sensitivity and manual dexterity. Natural rubber latex for superior protection.



Cat No	Product	Pack Size	Price
CLS-LS	Latex Examination Powder free Gloves, Small	100/pk 10pk/Case	710.00 6745.00
CLS-LM	Latex Examination Powder free Gloves, Medium	100/pk 10pk/Case	710.00 6745.00
CLS-LL	Latex Examination Powder free Gloves, Large	100/pk 10pk/Case	710.00 6745.00

### High Temperature Gloves

Para-aramid based fabric is a remarkable fiber that provides strength to protect under extreme conditions. These gloves are substitute for asbestos gloves and most suitable for handling high temperature items. Gloves provide excellent hand protection without sacrificing manual dexterity or comfort and offering exceptional resistance to cut, slash and tear. Gloves made of fabric do not burn and will not melt and is most suitable substitute of asbestos gloves. Gloves are most suitable against open flame and hot metal splashes and can withstand temperature up to 350oC and with heavy woolen insulation up to 550oC.



Cat No	Product	Pk Size	Price
CLS018	High Temperature Gloves	1 Pair	4000.00

### Cryo Gloves

Cryo-Gloves are multi layer insulated gloves designed to provide protection to the hands and arms from the hazard encountered when working with ultra cold. They are light weight, flexible, durable, clean, allow for excellent dexterity, are very comfortable wear for extended periods and are extremely warm.



Cat No	Product	Pk Size	Price
CLS Cyro S	Cryo Gloves Small	1 Pair	18020.00
CLS Cyro M	Cryo Gloves Medium	1 Pair	18020.00
CLS Cyro L	Cryo Gloves Large	1 Pair	18020.00

### Parafilm

We are among the distinguished names in the industry, engaged in offering Parafilm Tape to our valuable customers. The offered parafilms tape are manufactured as per the prevailing industry standards and are known for their moisture holding capacity. These parafilms are precise in terms of dimensions and are made available at competitive prices



Cat No	Film Width	Roll Length	w x h x d, mm	Price
CLS-502A	50 mm (2-inch)	75 m	135 x 58 x 132	3500.00
CLS-1004A	100 mm (4-inch)	38 m	132 x 135 x 112	4500.00

### Sealing Film

The Sealing Film was developed with the assistance of a major cycler manufacturer for PCR applications. Not only does it offer low-auto fluorescence but it will prevent vapor loss and is thermostable and functional from -70 °C to +95°C. Certified RNase, DNase and DNA-free. DMSO resistant. This transparent sealing tape consists of a 2.0 mil polyolefin film coated on one side with a pressure sensitive acrylate adhesive which does not interfere with cycle reactions.

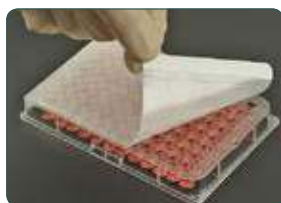

Cat No	Product	Pk Size	Price
CLS-418	Sealing Film, 50 Sheets	1PK	3510.00
CLS-418-S	Sealing Film, Sterile, 50 Sheets	1PK	3780.00

### 96-Well PCR Plate

96 Well PCR Plates are non-skirted for optimal flexibility. The raised rim of each well ensures a reduced risk of cross contamination and more effective adhesive film sealing to ensure samples (up to 200µl) remain intact. These PCR Plates are suitable for thermal cyclers and because of the high quality polypropylene material, PCR and qPCR applications can be conducted with confidence.

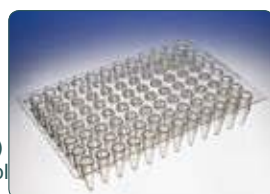

Specifications

- Non-skirted for optimal flexibility
- Reduced risks of cross contamination
- Improved adhesive film sealing
- High quality polypropylene

Cat No	Product	Pk Size	Price
CLS034	96-Well PCR Plate 5 plates/pk	5 plates/pk	1890.00

### Autoclave Indicator Tap

Description

The Autoclave indicator Tape consists of an adhesive, backing and chemical indicator strips. The adhesive is an aggressive, pressure-sensitive designed to adhere to a variety of wraps, including woven, treated woven, non-woven, paper and paper/plastic wraps in order to secure the pack during steam sterilization. After sterilization, the tape is designed to remove easily and cleanly from treated and untreated woven wraps. The backing is a saturated crepe paper and provides the stretch needed for pack expansion during sterilization. The chemical indicator lines will turn dark-brown/black on beige background when exposed at a steam sterilization process.



Cat No	Product	Pk Size	Price
CLS011	Autoclave Indicator Tape	1 ROLLS	5400.00

### Inoculating Loops & L Shaped Spreader

The inoculating loops are made of PS material offers high flexibility provide comfortable, stable and uniform streaking without damage to nutrient surface. The pre-Sterile L Shaped spreaders are ideal for spreading of samples on agar surfaces without disturbing media layer. It has smooth rounded surface to prevent any cutting or gouging of agar inoculation of culture plates. L Shape enables even spreading

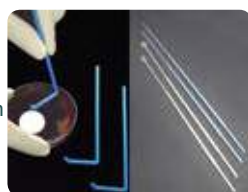

Cat No	Capacity	Pack	Price
CLS10001	1ul Sterile Loop	10/Pk, 100/Case	464.00
CLS10001-1	1ul Sterile Loop	1/Pk, 100/Case	600.00
CLS10010	10ul Sterile Loop	10/Pk, 100/Case	464.00
CLS10010-1	10ul Sterile Loop	1/Pk, 100/Case	600.00
CLS10000	L Shaped Spreader-Sterile	10/Pk. 100/Pack	1280.00

### Autoclave Bag

- Allow for repeated autoclaving
- Strong side seams for security holding items
- Thickness: 2.0 mil thick polypropylen
- Temperature: 121 °C (250 °F)



Cat No	Size	Pack	Price
CLS/AB/1225	310 x 660 mm	500/Pack	15333.00
CLS/AB/1625	415 x 600 mm	500/Pack	18333.00
CLS/AB/2432	610 x 810 mm	500/Pack	21333.00

### Bio Hazard Bag

A range of biohazard collection bag printed with biohazard warning symbol.



Cat No	Size	Color	Pack	Price
CLS/1224WR	12 x 24 inches	White (Red Print)	500/Pack	14500.00
CLS/2436	24 x 36 inches	Red	500/Pack	21200.00
CLS/1624Y	16 x 24 inches	Yellow	500/Pack	19300.00

### Petri Dish

- Used by microbiologists to culture Micro-organism on solid media
- Non vented dishes have lid which fits flatly on the base resulting in less potential for external contamination and significantly reduced evaporation rate.



Cat No	Product	Pk Size	Price
CLS-P-90	Petri Dish, Disposable, 90mm Single Room, Sterile, Individual Pack	500/pk	5200.00

### Protective Eyewear

These products are intended for protection against high speed particles at low energy (F) at extreme temperature conditions, -5 °C and +55°C (T) in accordance with EN166:2001. They also protect against UV radiation in accordance with EN170:2002.

- This protective eyewear has been shown to meet the basic safety requirements under Article 10 of the European Community Directive 89/686/EEC and is thus CE marked.
- These products have been examined at the design stage by INSPEC International Ltd., 56 Leslie Hough way, Salford, Greater Manchester, M6 6AJ,

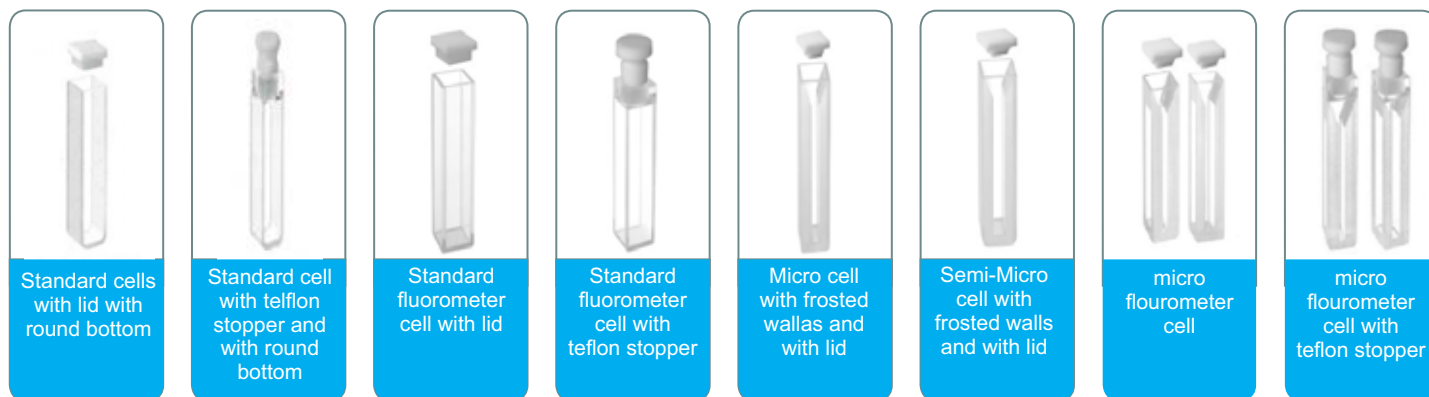

Cat No	Description	Pack Size	Price
CLS1709	Protective Eyewear	1/pk	700.00

**Cuvette**

\* Q=Quartz G=Optical Glas

**Specifications - Standard cells with lid with round bottom(2/PK)**

Outside Dim HxWxD mm	Path Lenght mm	Inside Width mm	Volume ml	ES Qyarz Glass 190nm-2500nm	Product Number		
					Price	Optical Glass 340nm-2500nm	Price
45×12.5×3.5	1	10	0.35	CQ-101	15050.00	CG-101	4610.00
45×12.5×4.5	2	10	0.7	CQ-102	12875.00	CG-102	4175.00
45×12.5×7.5	5	10	1.7	CQ-103	7220.00	CG-103	2653.00
45×12.5×12.5	10	10	3.5	CQ-104	5480.00	CG-104	2653.00
45×12.5×22.5	20	10	7	CQ-105	12875.00	CG-105	3610.00
45×12.5×32.5	30	10	10.5	CQ-106	15050.00	CG-106	3697.00
45×12.5×42.5	40	10	14	CQ-107	17225.00	CG-107	3740.00
45×12.5×52.5	50	10	17.5	CQ-108	17225.00	CG-108	3740.00
45×12.5×102.5	100	10	35	CQ-109	30275.00	CG-109	7220.00

**Specifications - Standard cell with teflon stopper and with round bottom(2/PK)**

45x 12.5x 12.5	10	10	3.5	CQ-114	15050.00	CG-114	6350.00
----------------	----	----	-----	--------	----------	--------	---------

**Specifications - Standard fluorometer cell with lid(2/PK)**

45x 12.5x 12.5	10	10	3.5	CQ-204	15050.00	CG-204	6350.00
----------------	----	----	-----	--------	----------	--------	---------

**Specifications - Standard fluorometer cell with lid(2/PK)**

45x 12.5x 12.5	10	10	3.5	CQ-214	17225.00	CG-214	8525.00
----------------	----	----	-----	--------	----------	--------	---------

**Specifications - Semi-Micro cell with frosted walls and with lid(2/PK)**

45x 12.5x 12.5	10	1	0.35	CQ-234	10700.00	CG-234	8525.00
45x 12.5x 12.5	10	2	0.7	CQ-244	10700.00	CG-244	8525.00
45x 12.5x 12.5	10	3	1	CQ-254	10700.00	CG-254	8525.00

**Specifications - Micro cell with frosted walls and with lid(2/PK)**

45x 12.5x 12.5	10	4	1.4	CQ-264	10700.00	CG-264	8525.00
45x 12.5x 12.5	10	5	1.7	CQ-274	10700.00	CG-274	8525.00

**Specifications - Micro fluourometer cell(2/PK)**

45x 12.5x 12.5	10	1	0.35	CQ-504	23750.00	CG-504	19400.00
45x 12.5x 12.5	10	2	0.7	CQ-514	23750.00	CG-514	19400.00
45x 12.5x 12.5	10	3	1	CQ-524	23750.00	CG-524	19400.00
45x 12.5x 12.5	10	4	1.4	CQ-534	23750.00	CG-534	19400.00

**Specifications - Micro fluourometer cell(2/PK)**

45x 12.5x 12.5	10	1	0.35	CQ-554	25490.00	CG-554	21575.00
45x 12.5x 12.5	10	2	0.7	CQ-564	25490.00	CG-564	21575.00
45x 12.5x 12.5	10	3	1	CQ-574	25490.00	CG-574	21575.00
45x 12.5x 12.5	10	4	1.4	CQ-584	25490.00	CG-584	21575.00

### Micro Pipette Tips

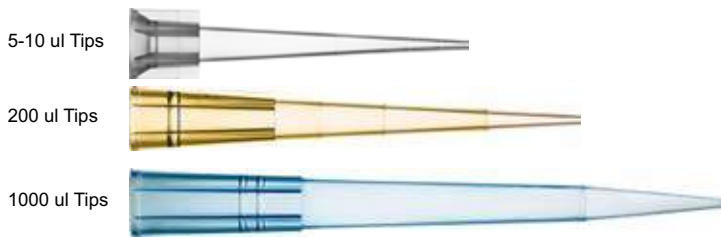

Cat No	Product	Pack	Price
C10MT	Micro Tips 5-10 ul, polypropylene,	1000/pk 20pk/Case	950.00 12240.00
C200MT	Pipette Tips 200 ul, polypropylene, autoclavable	1000/pk 20pk/Case	720.00 8840.00
C1000MT	Pipette Tips 1000 ul, polypropylene, autoclavable	1000/pk 20pk/Case	1500.00 21760.00

### Filter Tips

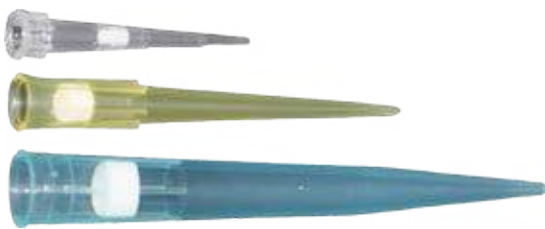

Filter tips are especially suited for working with PCR. Filter tips are produced from High quality colour Less granules. of Virgin ploypropylene to minimize liquid retention ensure most accurate and consistent result. The hydrophobic filter maximize tip performance and prevents particles to reach pipettor. (96/Rack)

Cat No	Product	Pack Size	Price
CLS12010-R	10 ul with Filter Low Retention, Sterilized, Rack Pack	20 Rack/Pack	19375.00
CLS12200-R	200 ul with Filter Low Retention, Sterilized, Rack Pack	20 Rack/Pack	19375.00
CLS12000-R	1000 ul with Filter Low Retention, Sterilized, Rack Pack	20 Rack/Pack	22475.00

### Centrifuge Tubes Standards

Standard quality Centrifuge tubes are made from highquality polypropylene assures good transparency and chemical resistibility. The bold white color graduations and writing areas are clear and are chloroform resistant. These tubes are leak proof and can be autoclaved to 121 °C /Freezable to -80 °C.



Cat No	Product	Pack Size	Price
CLS0015	15 ml	500/Box, 1000 Pack	10370.00
CLS0050	50 ml	500/Pack	8415.00
CLS1015	15 ml Sterilized	500/Box, 1000/Pack	12665.00
CLS1050	50 ml Sterilized	500/Pack	9520.00

### PCR And Micro Centrifuge Tubes

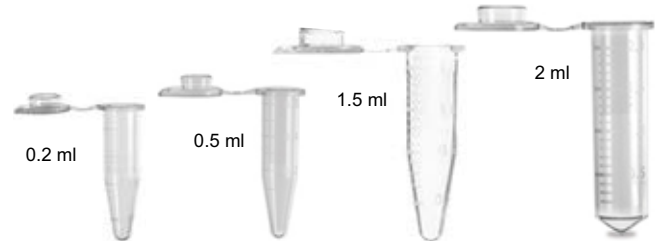

Cat No	Product	Pack	Price
C200LT	0.2ml PCR Tube, Polypropylene Clear, Graduated, Conical Bottom	1000/pk, 20pk/Case	4400.00 79200.00
C500LT	0.5ml Tube, Polypropylene Clear, Graduated, Conical Bottom	1000/pk, 20pk/Case	2500.00 31500.00
C1.5MCT	1.5ml CentrifugeTube, Polypropylene Clear, Graduated, Conical Bottom, Flat Cap.	1000/pk, 20pk/Case	1500.00 23500.00
C2MCT	2ml CentrifugeTube, Polypropylene Clear, Graduated, Conical Bottom, Flat Cap	1000/pk, 20pk/Case	1800.00 27500.00

### Centrifuge Tubes Premium

Centrifuge tubes Personal quality are made from medical grads superior 100% virgin polypropylene assures good transparency chemical resistibility and havelow retension surface. Thus tubes are available either Sterilized or Non Sterilizez in order to satisfy the diffrent research requirements. The Bold Black graduation and writing area are clear and are chloroform resistant. These tubes are Leakproof can be autoclaved to 121 °C /Freezable to -80 °C.



Cat No	Capacity	Pack Size	Price
CLS00015	15 ml	50/Bag, 500/Box, 1000/Pack	15215.00
CLS00050	50 ml	50/Bag, 500/Pack	10200.00
CLS10015	15 ml Sterilized	25/Bag, 500/Box, 1000/Pack	18700.00
CLS10050	50 ml Sterilized	25/Bag, 500/Pack	12325.00

### Pipette Tips Box

PP withstand Autocalving and Freezing



Cat No	Product	Pack Size	Price
CLS0010	10 ul	4	1600.00
CLS0200	200 ul	4	1600.00
CLS1000	1000 ul	4	1840.00

### Pasteur Pipettes

Pasteur are made of PE-LD and are perfect products for transfer of fluids in a quick and safe way.



Cat No	Capacity	Pack	Price
CLS00001	1 mL, Non Sterile	500 Box, 10 Box/Pack	9520.00
CLS10001	1 mL, Sterile	100 Box, 10 Box/Pack	6320.00
CLS00003	3 mL, Non Sterile	500 Box, 10 Box/Pack	9420.00
CLS10003	3 mL, Sterile	100 Box, 10 Box/Pack	6320.00

## Syringe Filters

### Introduction

BRBLS Syringe Filters are simply quality filters, well packaged, and offered at a fair. The Classic range is available in all of the major membranes including Nylon, PES, MCE, PVDF, CA and GF which are supplied in 13mm, 17mm, 25mm and 30mm formats in virgin polypropylene housing.

### Feature

- Application Compatibility: Broad range of filtration media meets diverse application needs
- Minimum sample hold-up: Syringe Filter's housings are specifically designed to maximize sample recovery
- Convenient: Each unit is clearly marked with an identifying code to denote pore size, membrane material

### Application

- HPLC sample preparation
- Routine QC analysis
- Content uniformity
- Removal of protein precipitates
- Dissolution testing
- Food analysis
- Biofuel analysis
- Environmental samples

#### Syringe Filters Selection Guide

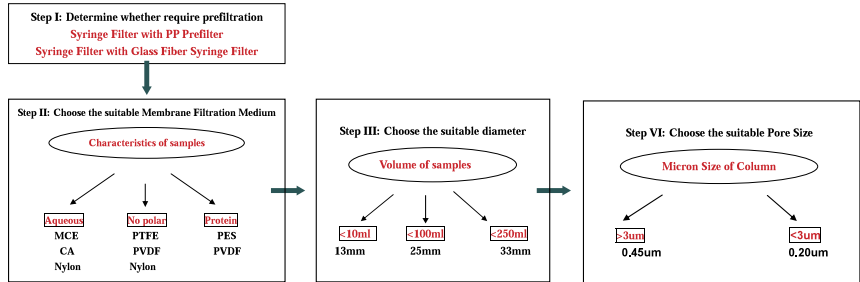

### Syringe Filter (Non Sterile)

Cat No.	Dia(mm)	Pore Size (um)	Material	Package	Price
CLSF01	13	0.45	Nylon 66	100 Pcs/box	4140.00
CLSF02	13	0.22	Nylon 66	100 Pcs/box	4140.00
CLSF03	13	0.45	PES	100 Pcs/box	4140.00
CLSF04	13	0.22	PES	100 Pcs/box	4140.00
CLSF05	25	0.45	Nylon 6	100 Pcs/box	5865.00
CLSF06	25	0.22	Nylon 6	100 Pcs/box	5865.00
CLSF07	25	0.45	PES	100 Pcs/box	5865.00
CLSF08	25	0.22	PES	100 Pcs/box	5865.00
CLSF09	25	0.45	Nylon 66	100 Pcs/box	7935.00
CLSF10	25	0.22	Nylon 66	100 Pcs/box	7935.00
CLSF11	13	0.45	MCE	100 Pcs/box	2760.00
CLSF12	13	0.22	MCE	100 Pcs/box	2760.00
CLSF13	25	0.45	MCE	100 Pcs/box	4830.00
CLSF14	25	0.22	MCE	100 Pcs/box	4830.00
CLSF15	13	0.45	PTFE	100 Pcs/box	5520.00
CLSF16	13	0.22	PTFE	100 Pcs/box	5520.00
CLSF17	25	0.45	PTFE	100 Pcs/box	8280.00
CLSF18	25	0.22	PTFE	100 Pcs/box	8250.00
CLSF19	13	0.45	GHP	100 Pcs/box	15600.00
CLSF20	13	0.22	GHP	100 Pcs/box	15600.00
CLSF21	25	0.45	GHP	100 Pcs/box	33300.00
CLSF22	25	0.22	GHP	100 Pcs/box	33300.00
CLSF23	13	0.45	PVDF	100 Pcs/box	6210.00
CLSF24	13	0.22	PVDF	100 Pcs/box	6210.00
CLSF25	25	0.45	PVDF	100 Pcs/box	10350.00
CLSF26	25	0.22	PVDF	100 Pcs/box	10350.00



### Syringe Filter Ordering information (sterile)

Nylon66 Syringe Filter (Polyamide-66, 13mm/25mm)

Cat No.	Product	Package	Price
CLSNY013022S	Sterile Nylon Syringe Filters, Pore:0.22(um), Housing Diameter:13(mm)	100	11400.00
CLSNY013045S	Sterile Nylon Syringe Filters, Pore:0.45(um), Housing Diameter:13(mm)	100	11400.00
CLSNY025022S	Sterile Nylon Syringe Filters, Pore:0.22(um), Housing Diameter:25(mm)	100	13200.00
CLSNY025045S	Sterile Nylon Syringe Filters, Pore:0.45(um), Housing Diameter:25(mm)	100	13200.00
CLSNY030022S	Sterile Nylon Syringe Filters, Pore:0.22(um), Housing Diameter:30(mm)	100	15000.00
CLSNY030045S	Sterile Nylon Syringe Filters, Pore:0.45(um), Housing Diameter:30(mm)	100	15000.00





PES Syringe Filter (Polyethersulfone)

Cat No.	Product	Package	Price (₹)
CLSPES013022S	Sterile PES Syringe Filters, Pore:0.22(µm), Housing Diameter:13(mm)	100	10800.00
CLSPES013045S	Sterile PES Syringe Filters, Pore:0.45(µm), Housing Diameter:13(mm)	100	10800.00
CLSPES025022S	Sterile PES Syringe Filters, Pore:0.22(µm), Housing Diameter:25(mm)	100	12600.00
CLSPES025045S	Sterile PES Syringe Filters, Pore:0.45(µm), Housing Diameter:25(mm)	100	12600.00
CLSPES030022S	Sterile PES Syringe Filters, Pore:0.22(µm), Housing Diameter:30(mm)	100	14400.00
CLSPES030045S	Sterile PES Syringe Filters, Pore:0.45(µm), Housing Diameter:30(mm)	100	14400.00



Syringe Filter (Cellulose Acetate)

Cat No.	Product	Package	Price (₹)
CLSCA013022S	Sterile CA Syringe Filters, Pore:0.22(µm), Housing Diameter:13(mm)	100	10800.00
CLSCA013045S	Sterile CA Syringe Filters, Pore:0.45(µm), Housing Diameter:13(mm)	100	10800.00
CLSCA025022S	Sterile CA Syringe Filters, Pore:0.22(µm), Housing Diameter:25(mm)	100	12600.00
CLSCA025045S	Sterile CA Syringe Filters, Pore:0.45(µm), Housing Diameter:25(mm)	100	12600.00
CLSCA030022S	Sterile CA Syringe Filters, Pore:0.22(µm), Housing Diameter:30(mm)	100	14400.00
CLSCA030045S	Sterile CA Syringe Filters, Pore:0.45(µm), Housing Diameter:30(mm)	100	14400.00



Syringe Filter (Polyvinylidene Fluoride)

Cat No.	Product	Package	Price (₹)
CLSPF013022S	Sterile Hydrophobic PVDF Syringe Filters, Pore:0.22(µm), Housing Diameter:13(mm)	100	11400.00
CLSPF013045S	Sterile Hydrophobic PVDF Syringe Filters, Pore:0.45(µm), Housing Diameter:13(mm)	100	11400.00
CLSPF025022S	Sterile Hydrophobic PVDF Syringe Filters, Pore:0.22(µm), Housing Diameter:25(mm)	100	13200.00
CLSPF025045S	Sterile Hydrophobic PVDF Syringe Filters, Pore:0.45(µm), Housing Diameter:25(mm)	100	13200.00
CLSPF030022S	Sterile Hydrophobic PVDF Syringe Filters, Pore:0.22(µm), Housing Diameter:30(mm)	100	15000.00
CLSPF030045S	Sterile Hydrophobic PVDF Syringe Filters, Pore:0.45(µm), Housing Diameter:30(mm)	100	15000.00



## Membrane Filter

Membrane filters or “membranes” are microporous films with specific pore size ratings. Membranes retain particles and microorganisms that exceed their pore ratings by acting as a physical barrier and capturing such particles on the surface of the membrane.

### Application

- General clean and filtration
- Sample Prep
- Environmental Monitoring and Analysis
- Filtration of Aqueous and Organic Solutions
- Fluid Monitoring
- Pharmaceutical Products Analysis
- Chromatography and Mass Spec Sample Prep
- Venting and Gas Filtration

### Feature

- High Porosity: BRBLS<sup>™</sup> thin membrane with high porosity provide high liquid and gas low per unit area. High porosity also provides high surface area for adsorption or binding
- Clean: As part of comprehensive quality program, only high purity raw materials and reagents are used to produce BRBLS membranes.
- Strong: BRBLS<sup>™</sup> membranes are monitored for both burst and tensile strength. PTFE and Nylon are very strong for most aggressive applications.

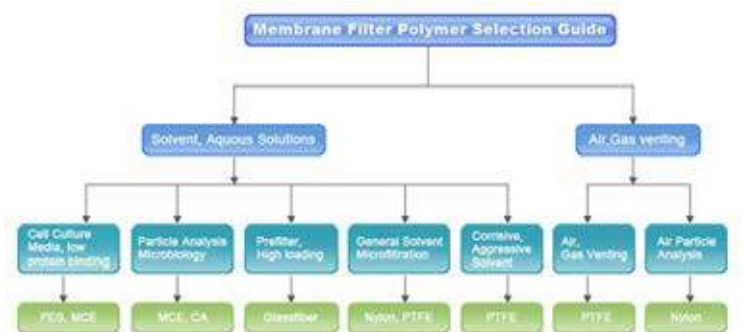

Sterile MiCE membrane filter, gridded, individually package

Cat No.	Product	Package	Price (₹)
CLSMCE047022GWS	MCE Gridded Membrane Filter, White, Sterile, 0.22(µm), 47(mm)	100	4680.00
CLSMCE047045GWS	MCE Gridded Membrane Filter, White, Sterile, 0.45(µm), 47(mm)	100	4680.00



Cat No.	Product	Package	Price
CLSMCE047080GWS	MCE Gridded Membrane Filter, White, Sterile, 0.8(μm), 47(mm)	50	4680.00
CLSMCE050022GWS	MCE Gridded Membrane Filter, White, Sterile, 0.22(μm), 50(mm)	50	4680.00
CLSMCE050045GWS	MCE Gridded Membrane Filter, White, Sterile, 0.45(μm), 50(mm)	50	4680.00
CLSMCE050080GWS	MCE Gridded Membrane Filter, White, Sterile, 0.8(μm), 50(mm)	50	4680.00
CLSMCE047022GWSP	MCE Gridded Membrane Filter, White, Sterile, 0.22(μm), 47(mm),With Pad	50	6600.00
CLSMCE047045GWSP	MCE Gridded Membrane Filter, White, Sterile, 0.45(μm), 47(mm),With Pad	50	6600.00
CLSMCE047080GWSP	MCE Gridded Membrane Filter, White, Sterile, 0.80(μm), 47(mm),With Pad	50	6600.00



Nylon Membrane Filter

Cat No.	Product	Package	Price
CLSNY013022	Nylon Membrane Filter, Pore:0.22(μm), Diameter:13(mm)	50	5640.00
CLSNY025022	Nylon Membrane Filter, Pore:0.22(μm), Diameter:25(mm)	50	4800.00
CLSNY047022	Nylon Membrane Filter, Pore:0.22(μm), Diameter:47(mm)	50	7650.00
CLSNY090022	Nylon Membrane Filter, Pore:0.22(μm), Diameter:90(mm)	50	11190.00
CLSNY142022	Nylon Membrane Filter, Pore:0.22(μm), Diameter:142(mm)	50	16410.00
CLSNY293022	Nylon Membrane Filter, Pore:0.22(μm), Diameter:293(mm)	25	20850.00
CLSNY013045	Nylon Membrane Filter, Pore:0.45(μm), Diameter:13(mm)	50	5640.00
CLSNY025045	Nylon Membrane Filter, Pore:0.45(μm), Diameter:25(mm)	50	4800.00
CLSNY047045	Nylon Membrane Filter, Pore:0.45(μm), Diameter:47(mm)	50	7650.00
CLSNY090045	Nylon Membrane Filter, Pore:0.45(μm), Diameter:90(mm)	50	11190.00
CLSNY142045	Nylon Membrane Filter, Pore:0.45(μm), Diameter:142(mm)	50	16410.00
CLSNY293045	Nylon Membrane Filter, Pore:0.45(μm), Diameter:293(mm)	25	21750.00
CLSNY013080	Nylon Membrane Filter, Pore:0.8(μm), Diameter:13(mm)	50	8460.00
CLSNY025080	Nylon Membrane Filter, Pore:0.8(μm), Diameter:25(mm)	50	7200.00
CLSNY047080	Nylon Membrane Filter, Pore:0.8(μm), Diameter:47(mm)	50	11475.00
CLSNY090080	Nylon Membrane Filter, Pore:0.8(μm), Diameter:90(mm)	50	16785.00
CLSNY142080	Nylon Membrane Filter, Pore:0.8(μm), Diameter:142(mm)	50	24615.00
CLSNY293080	Nylon Membrane Filter, Pore:0.8(μm), Diameter:293(mm)	25	32625.00
CLSNY013100	Nylon Membrane Filter, Pore:1.2(μm), Diameter:13(mm)	50	8460.00
CLSNY025100	Nylon Membrane Filter, Pore:1.2(μm), Diameter:25(mm)	50	7200.00
CLSNY047100	Nylon Membrane Filter, Pore:1.2(μm), Diameter:47(mm)	50	11475.00
CLSNY090100	Nylon Membrane Filter, Pore:1.2(μm), Diameter:90(mm)	50	16785.00
CLSNY142100	Nylon Membrane Filter, Pore:1.2(μm), Diameter:142(mm)	50	24615.00
CLSNY293100	Nylon Membrane Filter, Pore:1.2(μm), Diameter:293(mm)	25	32625.00
CLSNY013300	Nylon Membrane Filter, Pore:3.0(μm), Diameter:13(mm)	50	8460.00
CLSNY025300	Nylon Membrane Filter, Pore:3.0(μm), Diameter:25(mm)	50	7200.00
CLSNY047300	Nylon Membrane Filter, Pore:3.0(μm), Diameter:47(mm)	200	11475.00
CLSNY090300	Nylon Membrane Filter, Pore:3.0(μm), Diameter:90(mm)	50	16785.00
CLSNY142300	Nylon Membrane Filter, Pore:3.0(μm), Diameter:142(mm)	50	24615.00
CLSNY293300	Nylon Membrane Filter, Pore:3.0(μm), Diameter:293(mm)	25	32625.00
CLSNY013500	Nylon Membrane Filter, Pore:5.0(μm), Diameter:13(mm)	50	8460.00



Cat No.	Product	Package	Price
CLSNY025500	Nylon Membrane Filter, Pore:5.0(μm), Diameter:25(mm)	50	7200.00
CLSNY047500	Nylon Membrane Filter, Pore:5.0(μm), Diameter:47(mm)	50	11475.00
CLSNY090500	Nylon Membrane Filter, Pore:5.0(μm), Diameter:90(mm)	50	16785.00
CLSNY142500	Nylon Membrane Filter, Pore:5.0(μm), Diameter:142(mm)	50	24615.00
CLSNY293500	Nylon Membrane Filter, Pore:5.0(μm), Diameter:293(mm)	25	32625.00

**Hydrophilic PTFE Membrane Filter (Poly(Tetrafluoroethylene))**

Cat No.	Product	Package	Price
CLSPTFE013022L	Hydrophilic PTFE Membrane Filter, Pore:0.22(μm), Diameter:13(mm)	50	16878.00
CLSPTFE025022L	Hydrophilic PTFE Membrane Filter, Pore:0.22(μm), Diameter:25(mm)	50	15762.00
CLSPTFE047022L	Hydrophilic PTFE Membrane Filter, Pore:0.22(μm), Diameter:47(mm)	50	29670.00
CLSPTFE090022L	Hydrophilic PTFE Membrane Filter, Pore:0.22(μm), Diameter:90(mm)	50	56370.00
CLSPTFE013045L	Hydrophilic PTFE Membrane Filter, Pore:0.45(μm), Diameter:13(mm)	50	16878.00
CLSPTFE025045L	Hydrophilic PTFE Membrane Filter, Pore:0.45(μm), Diameter:25(mm)	50	15762.00
CLSPTFE047045L	Hydrophilic PTFE Membrane Filter, Pore:0.45(μm), Diameter:47(mm)	50	29670.00
CLSPTFE090045L	Hydrophilic PTFE Membrane Filter, Pore:0.45(μm), Diameter:90(mm)	50	56370.00

**CA Membrane Filter (Cellulose Acetate)**

Cat No.	Product	Package	Price
CLSCA013022	CA Membrane Filter, Pore:0.22(μm), Diameter:13(mm)	50	7158.00
CLSCA025022	CA Membrane Filter, Pore:0.22(μm), Diameter:25(mm)	50	5820.00
CLSCA047022	CA Membrane Filter, Pore:0.22(μm), Diameter:47(mm)	50	7077.00
CLSCA090022	CA Membrane Filter, Pore:0.22(μm), Diameter:90(mm)	50	9720.00
CLSCA142022	CA Membrane Filter, Pore:0.22(μm), Diameter:142(mm)	50	12240.00
CLSPTFE090045L	Hydrophilic PTFE Membrane Filter, Pore:0.45(μm), Diameter:90(mm)	50	56370.00

**PES Membrane Filter (Polyethersulfone)**

Cat No.	Product	Package	Price
CLSPES013022	PES Membrane Filter, Pore:0.22(μm), Diameter:13(mm)	50	7584.00
CLSPES025022	PES Membrane Filter, Pore:0.22(μm), Diameter:25(mm)	50	7020.00
CLSPES047022	PES Membrane Filter, Pore:0.22(μm), Diameter:47(mm)	50	13845.00
CLSPES090022	PES Membrane Filter, Pore:0.22(μm), Diameter:90(mm)	50	26010.00
CLSPES142022	PES Membrane Filter, Pore:0.22(μm), Diameter:142(mm)	50	39690.00
CLSPES013045	PES Membrane Filter, Pore:0.45(μm), Diameter:13(mm)	50	7584.00
CLSPES025045	PES Membrane Filter, Pore:0.45(μm), Diameter:25(mm)	50	7020.00
CLSPES047045	PES Membrane Filter, Pore:0.45(μm), Diameter:47(mm)	50	13845.00
CLSPES090045	PES Membrane Filter, Pore:0.45(μm), Diameter:90(mm)	50	26010.00
CLSPES142045	PES Membrane Filter, Pore:0.45(μm), Diameter:142(mm)	50	39690.00
CLSPES013010	PES Membrane Filter, Pore:0.1(μm), Diameter:13(mm)	50	12276.00
CLSPES025010	PES Membrane Filter, Pore:0.1(μm), Diameter:25(mm)	50	10530.00
CLSPES047010	PES Membrane Filter, Pore:0.1(μm), Diameter:47(mm)	50	20769.00
CLSPES090010	PES Membrane Filter, Pore:0.1(μm), Diameter:90(mm)	50	39000.00



**PVDF Membrane Filter (Polyvinylidene fluoride)**

Cat No.	Product	Package	Price
CLSPVDF013022	PVDF Membrane Filter, Pore: 0.22(μm), Diameter: 13(mm)	50	7695.00
CLSPVDF025022	PVDF Membrane Filter, Pore: 0.22(μm), Diameter: 25(mm)	50	8289.00
CLSPVDF047022	PVDF Membrane Filter, Pore: 0.22(μm), Diameter: 47(mm)	50	12750.00
CLSPVDF090022	PVDF Membrane Filter, Pore: 0.22(μm), Diameter: 90(mm)	50	21240.00
CLSPVDF142022	PVDF Membrane Filter, Pore: 0.22(μm), Diameter: 142(mm)	50	30222.00
CLSPVDF013045	PVDF Membrane Filter, Pore: 0.45(μm), Diameter: 13(mm)	50	7695.00
CLSPVDF025045	PVDF Membrane Filter, Pore: 0.45(μm), Diameter: 25(mm)	50	8289.00
CLSPVDF047045	PVDF Membrane Filter, Pore: 0.45(μm), Diameter: 47(mm)	50	12750.00
CLSPVDF090045	PVDF Membrane Filter, Pore: 0.45(μm), Diameter: 90(mm)	50	19377.00
CLSPVDF142045	PVDF Membrane Filter, Pore: 0.45(μm), Diameter: 142(mm)	50	30222.00

**PP Membrane Filter (Polypropylene)**

Cat No.	Product	Package	Price
CLSP025022	PP Membrane Filter, Pore:0.22(μm), Diameter:25(mm)	50	5252.00
CLSP047022	PP Membrane Filter, Pore:0.22(μm), Diameter:47(mm)	50	7859.00
CLSP090022	PP Membrane Filter, Pore:0.22(μm), Diameter:90(mm)	50	8338.00
CLSP142022	PP Membrane Filter, Pore:0.22(μm), Diameter:142(mm)	50	9738.00
CLSP250022	PP Membrane Filter, Pore:0.22(μm), Diameter:250(mm)	50	12571.00
CLSP293022	PP Membrane Filter, Pore:0.22(μm), Diameter:293(mm)	25	16129.00
CLSP025045	PP Membrane Filter, Pore:0.45(μm), Diameter:25(mm)	50	4728.00
CLSP047045	PP Membrane Filter, Pore:0.45(μm), Diameter:47(mm)	50	7074.00
CLSP090045	PP Membrane Filter, Pore:0.45(μm), Diameter:90(mm)	50	7548.00
CLSP142045	PP Membrane Filter, Pore:0.45(μm), Diameter:142(mm)	50	8763.00
CLSP250045	PP Membrane Filter, Pore:0.45(μm), Diameter:250(mm)	50	11316.00
CLSP293045	PP Membrane Filter, Pore:0.45(μm), Diameter:293(mm)	25	14511.00

**Nitrocellulose Transfer (Blotting) Membrane**

Pure esters of nitrocellulose, free of acetate and other esters. Maximal protein/nucleic acid binding. upto 80 to 100 μg/cm<sup>2</sup> Nitrocellulose membranes are easily blocked, wet out naturally & do not require methanol. Recommended for western blotting. Two pore sizes available : 0.45 μm is suitable for protein & most blotting applications, 0.2 μm sizes for lower molecular weights.

Cat No.	Size	Micron Rating	Nos./Pkt.	Price
CLSNM101	300 mm x 300 mm	0.45	10	15920.00
CLSNM102	200 mm x 200 mm	0.45	10	12800.00
CLSNM103	100 mm x 100 mm	0.45	10	6400.00
CLSNM104	300 mm x 3 mts	0.45	One Roll	15840.00
CLSNM105	300 mm x 300 mm	0.20	10	15920.00
CLSNM106	200 mm x 200 mm	0.20	10	12800.00
CLSNM107	100 mm x 100 mm	0.20	10	6400.00
CLSNM108	300 mm x 3 mts	0.20	One Roll	



**Filter Paper**

Qualitative Filter Paper

Cat No	Diameter (mm)	Packing	Price
CLSQF102	60*60cm	100pcs/pack	23350.00
CLSQF103	7cm	100pcs/box	618.00
CLSQF104	9cm	100pcs/box	828.00
CLSQF105	11cm	100pcs/pack	1170.00
CLSQF106	12.5cm	100pcs/pack	1434.00
CLSQF107	15cm	100pcs/pack	1848.00
CLSQF108	18cm	100pcs/pack	2478.00
CLSQF109	20cm	100pcs/pack	3156.00
CLSQF110	24cm	100pcs/pack	4740.00
CLSQF111	25cm	100pcs/pack	5100.00
CLSQF112	28cm	100pcs/pack	6300.00



Ashless Filter Paper

Cat No	Diameter (mm)	Packing	Price
CLSQF202	7cm	100 pcs per/pack	1494.00
CLSQF203	9cm	100 pcs per/pack	2178.00
CLSQF204	11cm	100 pcs per/pack	3078.00
CLSQF205	12.5cm	100 pcs per/pack	3798.00
CLSQF206	15cm	100 pcs per/pack	4872.00
CLSQF207	18cm	100 pcs per/pack	6906.00

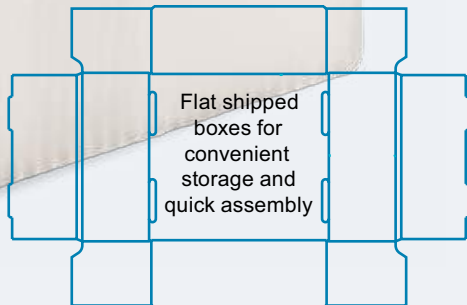
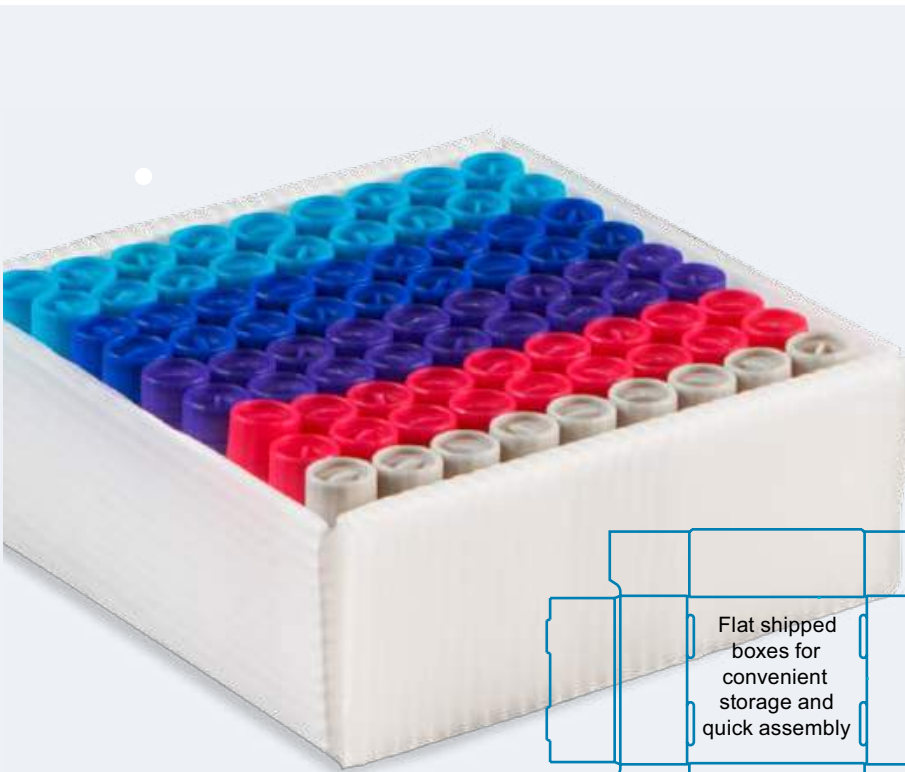

**Flatpack Freezer Boxes**  
*Reusable, economical and moisture resistant plastic*

These easy self-assemble boxes come flat-packed, ensuring valuable lab space is not taken up storing the boxes before they are needed. Made from corrugated polypropylene, they are more durable than card boxes as they are not susceptible to moisture, so they can be frozen and thawed numerous times without a problem.

- Pre-assembled dividers included with the boxes.
- Store down to temperatures of -80°C
- Holds 81 x 12 mm (max. diameter) tubes in a 9 x 9 format
- Complete with well dividers in packs of 10



## COMPOSITE LAB LINE PVT LTD

UGSR-1, Ansal Plaza, Vaishali

Delhi, NCR, Ghaziabad - 201010 (India)

Ph. : 0120-4335636 Mail : sales@compositelablin.com

Visit.: [www.compositelabline.com](http://www.compositelabline.com)

### Reg Office :

A-1, OKKP Complex, Near I.T.Crosing

Faizabad Road, Babujanj

Lucknow - 226020 (India)

Ph. : +919580613355, 0522 - 4068342

Mail : sales@compositelablin.com

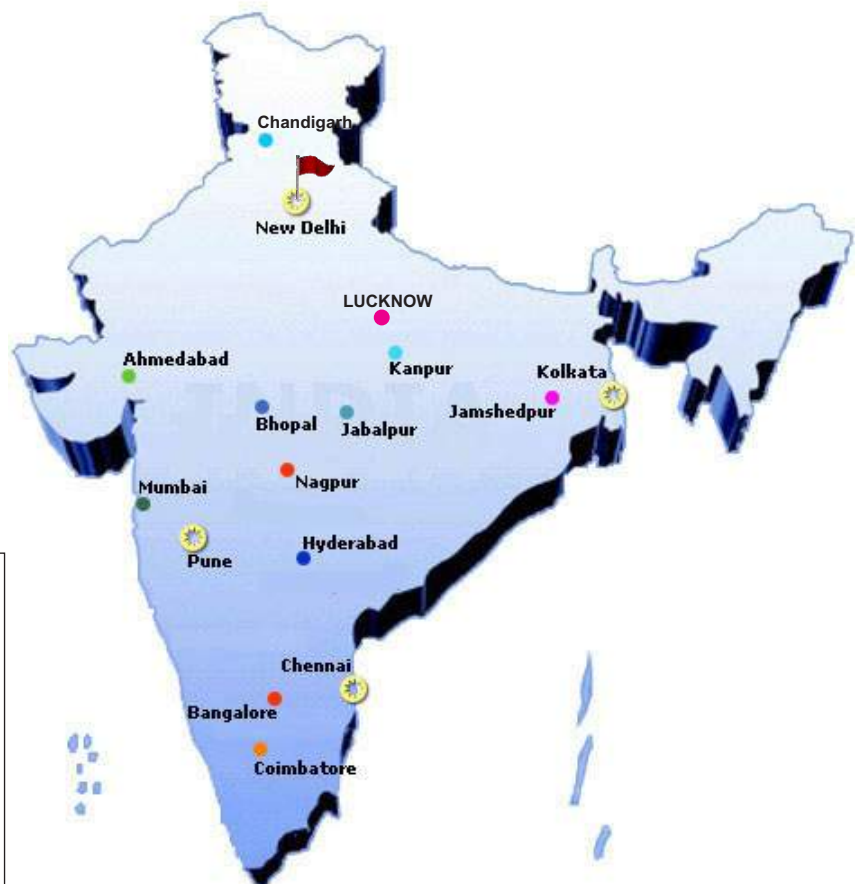

Authorised Dealer: